

SHEPARD

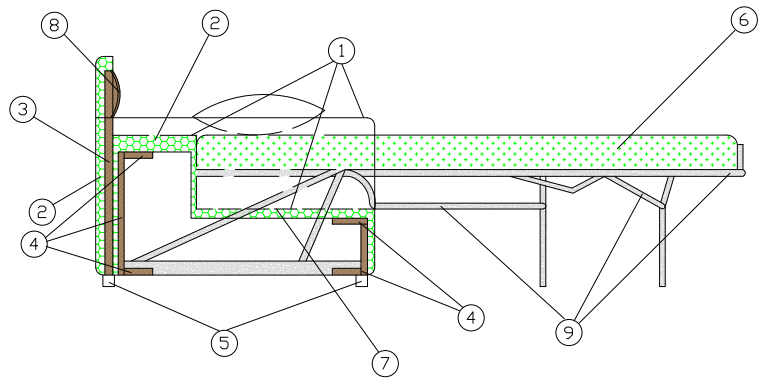
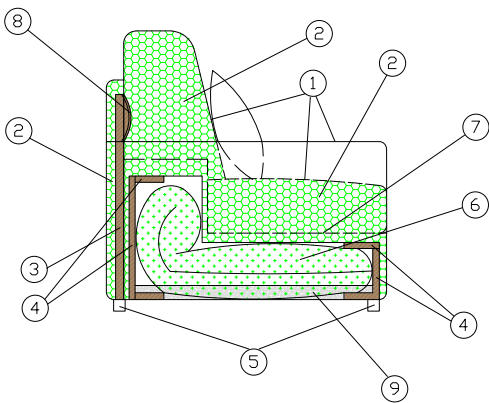

MATERIALS:

- 1- dacron® fiber 100 gr;
- 2- sitting cushion in high resiliency polyurethane foam, back cushion in feather and high resiliency polyurethane foam;
- 3- board in composite wood;
- 4- structural frame in composite wood;
- 5- ABS feet;

- 6- fire retardant or standard polyurethane mattress, with two-fold mechanism, h 12 cm, covered with antiallergic polyester lining;
- 7- elastic webbing;
- 8- cover in HDF;
- 9- high-resistance steel electrowelded mechanism.

SHEPARD

ARMREST:



SHEPARD COLLECTION:

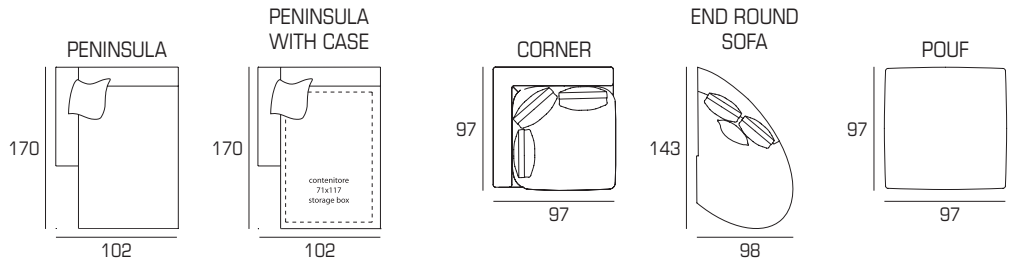
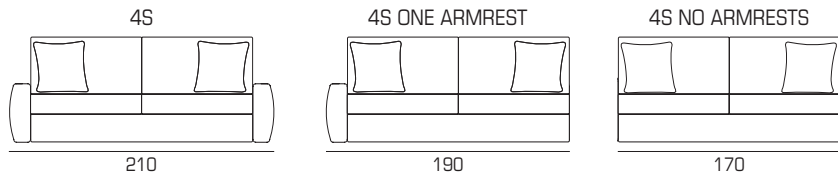
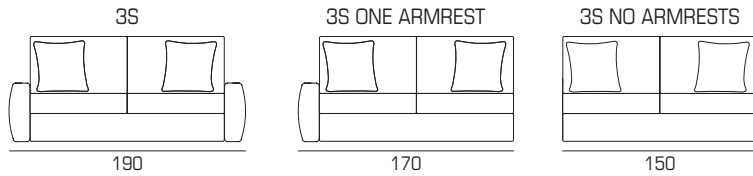
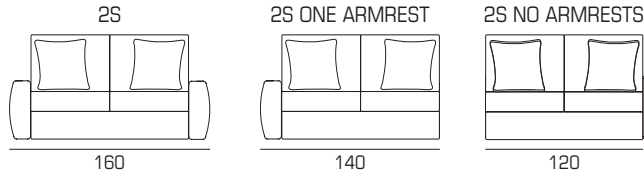
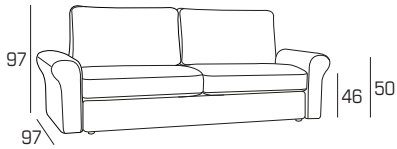

FEET:

P 25 h 2-4-6

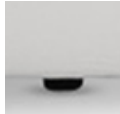

BED:

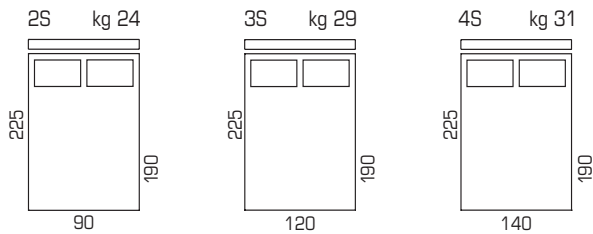

SHEPARD

MECHANISM BED SOFA:

Opening



REMOVE
cable ties on the sides before
lifting the sleeping deck

Opening folding the bed
incorrectly could damage
the mechanism

Closing

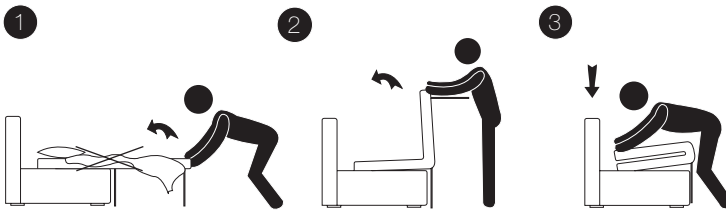

REMOVE
all sheet, blankets and pillows
before folding the sofa back up to
avoid breaking the mechanism

TECHNICAL DETAILS:

| Removable cover: NO | kg | m ³ | mts | | kg | m ³ | mts |
|------------------------|----|----------------|-------|-----------------------------|----|----------------|-------|
| SHEPARD 2S | 68 | 1.50 | 9.80 | SHEPARD 4S ONE ARMREST | 87 | 1.80 | 10.00 |
| SHEPARD 2S ONE ARMREST | 57 | 1.30 | 8.20 | SHEPARD 4S NO ARMRESTS | 75 | 1.60 | 9.20 |
| SHEPARD 2S NO ARMRESTS | 45 | 1.10 | 7.00 | SHEPARD PENINSULA | 82 | 1.65 | 8.50 |
| SHEPARD 3S | 89 | 1.80 | 10.70 | SHEPARD PENINSULA WITH CASE | 82 | 1.65 | 8.50 |
| SHEPARD 3S ONE ARMREST | 78 | 1.60 | 9.00 | SHEPARD CORNER | 45 | 0.90 | 8.00 |
| SHEPARD 3S NO ARMRESTS | 66 | 1.40 | 8.00 | SHEPARD END ROUND SOFA | 46 | 1.35 | 8.10 |
| SHEPARD 4S | 98 | 1.98 | 12.20 | SHEPARD POUF | 26 | 0.90 | 3.80 |